

Section 16

Manuals, Bags, Lubricants

Bungee Cords4-5
Cycle Covers8
Goggles4
Locks4
Lubricants 10
Manuals/Books.....2-3
Pouches9
Saddlebags and Supports5-8



Saddlebag Top Trim
For FLH 1980 and up, FLT 1980 & up, & FLHT 1983 & up.
4936 Kit for one top

Service Manuals



22568



22571



22563

Softail

PCP	Year	OEM
5942	1985-90	99482-90
22566	1991-92	99482-92
22560	1993-94	99482-94
22568	1995-96	99482-96A
22583	1997-98	99482-98
22584	1999	99482-99
22597	2000	99482-00A
22588	2001	99482-01A
22592	2002	99482-02A
22559	2003	99482-03
22630	2004	99482-04
22631	2005	99482-05
22655	2006	99482-06
22659	2007	99482-07
22662	2008	99482-08A
22663	2009	99482-09
22664	2010	99482-10

FLT/FLHR/FXR (Touring)

PCP	Year	OEM
5941	1984-90	99483-90
5944	1991-92	99483-92
22562	1993-94	99483-94A
22571	1995-96	99483-96A
22576	1997	99483-97A
22577	1998	99483-98
22578	1999	99483-99A
22598	2000	99483-00A
22590	2001	99483-01
22593	2002	99483-02
22558	2003	99483-03
22634	2004	99483-04A
22635	2005	99483-05
22657	2006	99483-06
22661	2007	99483-07
22665	2008	99483-08
22666	2009	99483-09
22667	2010	99483-10

XL

PCP	Year	OEM
5950	1986-90	99484-90
5954	1991-92	99484-92
22563	1993-94	99484-94
22570	1995-96	99484-96
22585	1997	99484-97
22586	1998	99484-98
22587	1999	99484-99
22599	2000	99484-00A
22589	2001	99484-01
22594	2002	99484-02
22557	2003	99484-03
22636	2004	99484-04A
22637	2005	99484-05
22656	2006	99484-06
22660	2007	99484-07
22668	2008	99484-08A
22669	2009	99484-09
22670	2010	99484-10

Dyna

PCP	Year	OEM
22564	1991-92	99481-92
22565	1993-94	99481-94
22572	1995-96	99481-96A
22580	1997-98	99481-98
22582	1999	99481-99A
22596	2000	99481-00
22591	2001	99481-01A
22555	2002	99481-02
22556	2003	99481-03
22632	2004	99481-04
22633	2005	99481-05
22654	2006	99481-06A
22658	2007	99481-07
22671	2008	99481-08
22672	2009	99481-09
22673	2010	99481-10

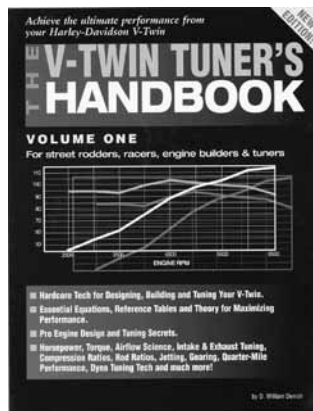

V-Twin Tuner's Handbook I

Includes essential equations, reference tables and theory for maximum performance, pro engine design and tuning secrets.

22508 158 pages

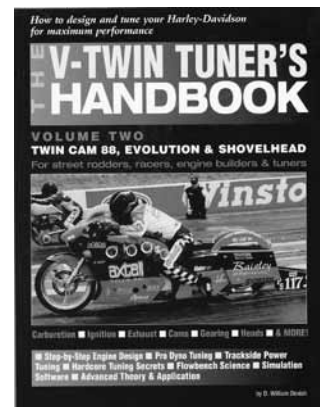

V-Twin Tuner's Handbook II

Includes instructions on how to design and tune for maximum performance. Describes step by step scientific engine design and advanced theory.

22509 270 pages

Parts Manuals

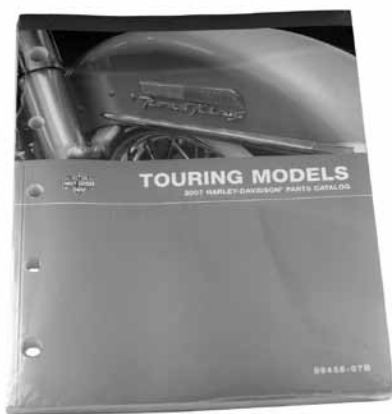

22653



22567

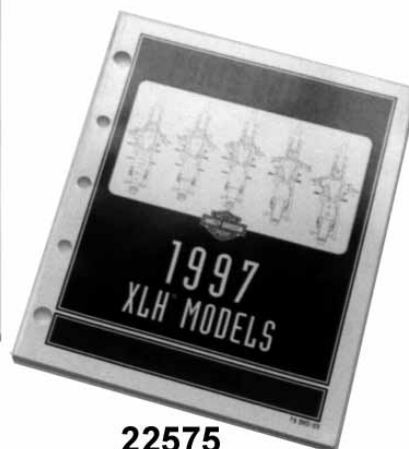

22575

Spare Parts Books

All Models detailed with exploded views and factory numbers.

FLT/ FLHR (Touring)

PCP	Year	OEM
5914	1984-86	99438-86B
22608	1997	99456-97A
22609	1998	99456-98A
22610	1999	99456-99A
22611	2000	99456-00A
22612	2001	99456-01A
22622	2002	99456-02A
22626	2003	99456-03
22638	2004	99456-04A
22639	2005	99456-05
22649	2006	99456-06
22653	2007	99456-07A
22674	2008	99456-08B
22675	2009	99456-09A
22676	2010	99456-10

FX

PCP	Year	OEM
5915	1985-86	99455-86A

Softail, Deuce 2000-on

PCP	Year	OEM
5915	1984-86	99455-86A
22605	1997	99455-97A
22606	1998	99455-98A
22607	1999	99455-99A
22616	2000	99455-00A
22617	2001	99455-01A
22625	2002	99455-02A
22629	2003	99455-03A
22640	2004	99455-04A
22641	2005	99455-05
22647	2006	99455-06A
22651	2007	99455-07A
22677	2008	99455-08A
22678	2009	99455-09
22679	2010	99455-10

All 80" Models

PCP	Year	OEM
5919	1987-90	99450-90A
5945	1991-92	99450-92
22561	1993-94	99450-94A
22567	1995-96	99450-96

Dyna

PCP	Year	OEM
22602	1997	99439-97A
22603	1998	99439-98A
22604	1999	99439-99A
22614	2000	99439-00A
22615	2001	99439-01A
22623	2002	99439-02A
22627	2003	99439-03
22642	2004	99439-04A
22643	2005	99439-05
22646	2006	99439-06A
22650	2007	99439-07A
22680	2008	99439-08A
22681	2009	99439-09
22682	2010	99439-10

Sportster

PCP	Year	OEM
5922	1986-90	99451-90
5923	1991-92	99451-92
5924	1993-94	99451-94
22569	1995-96	99451-96A
22575	1997	99451-97A
22618	1998	99451-98A
22619	1999	99451-99A
22620	2000	99451-00A
22621	2001	99451-01A
22624	2002	99451-02
22628	2003	99451-03
22644	2004	99451-04
22645	2005	99451-05
22648	2006	99451-06A
22652	2007	99451-07A
22683	2008	99451-08A
22684	2009	99451-09
22685	2010	99451-10

FXR, FXR2, FXR3

PCP	Year	OEM
5917	1984-86	99439-86A
22613	2000 FXR4	99429-00

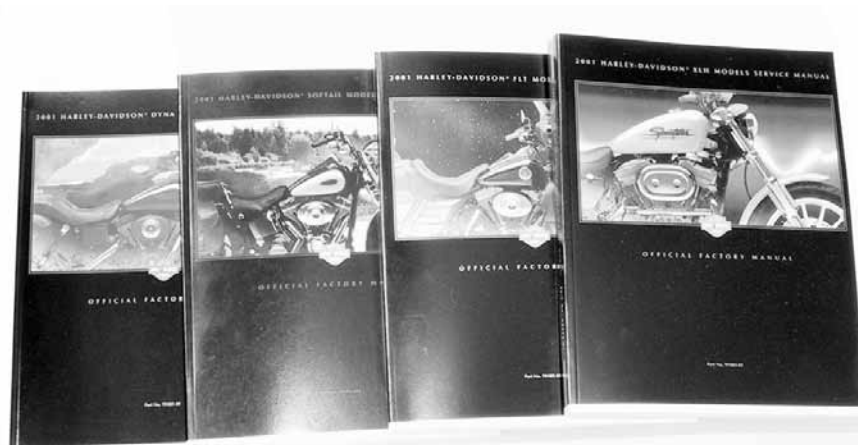

Locks



Pingel Stainless Steel Lock Holder

Includes 3/8" allen bolt to mount frame tubes.
73608



Self Adhesive Flame Trim

45134 8" chrome (each)
45133 6" chrome (each)

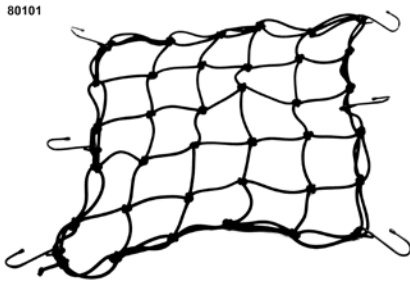

Cargo Nets

Made from multi-strand natural rubber wrapped with a knitted polyethylene black cover. Each has 6 poly-coated hooks to prevent scratching.

80100 Cargo net 12" x 17"
80101 Cargo net 15" x 15"



BT High Performance Guide

Includes new performance secrets for gaining more horsepower. 238 pages.
22507



Padlock

29400 45737-72A
29401 45721-96A



Universal Mount Helmet Lock

Designed to be installed on any 7/8" to 1-1/4" diameter tubing such as engine guards, saddlebag guards and frame tubes. Conveniently secures helmets while in restaurants, etc.
4927 Universal application



Conchos

Use this genuine leather set of 5 Conchos to dress up throw over bags.
5960 Conchos



Motorcycle Short Tie Downs

25900 Pair

Goggles



Over-glass Goggles

Goggle designed specifically for eye-glass wearers. Black leather trimmed goggles fit right over most prescription glasses, protecting your investment while providing additional riding comfort. They also feature acrylic lenses and pop-up air vents.
887



"Flying Tiger" Goggles

Features air vents, acrylic non-scratch one-piece lense, and cushioned head strap.
3539



Red Baron Goggles

Super-popular goggles with air vents, smoke-tint acrylic non-scratch lense, adjustable band and six-position lense adjuster for custom fit.
1329



Concho (Travelcade)

Features: Attaches to any existing luggage or most anything. Can be sewn, glued or riveted. Complete with tie straps. Size: Eagle 6" x 2". (Pair)
75650 Concho mounted on eagle

Saddlebags

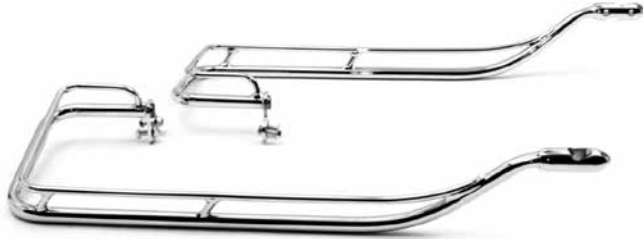

Chrome Saddlebag Guard Rails

Panhead style guard rails fit FLHT standard 1995-08, FLHS 1993, FLHR 1994-08 (except FLHRC/S, FLHX).
82055 90839-94A

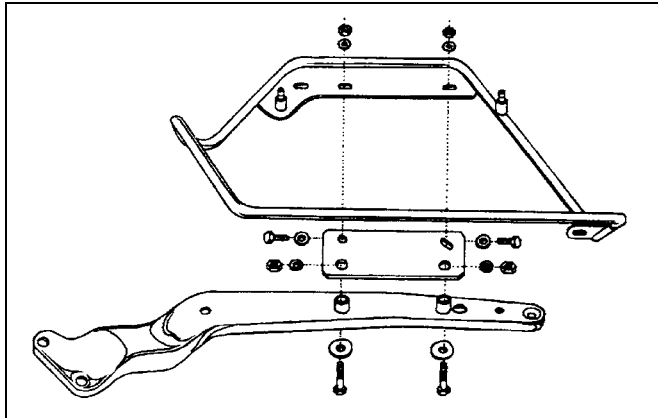

Fibreglass Saddlebag Mount Kit 1986-99

This kit mounts Preston #99980 fibreglass bags to Softails.
27139 Kit (2 plates & hardware) 1-3/4" c/c lowers



FLT Rails Set 1993-on

Includes 4 pieces to replace original rails.
82097

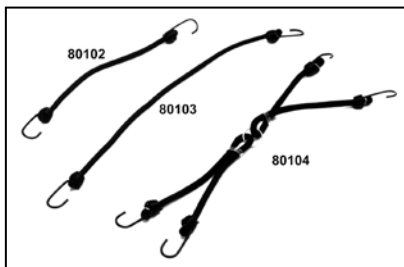

Black Bungee Cords

A plain black bungee cord to handle your tie-down needs without disrupting the appearance of your motorcycle. Sold in packs of 10.

- 80104** 22" long with four arms
- 80103** 24" long
- 80102** 16" long



82047



82049

82046

FLT, FLHT Saddlebag Lids

Lids feature a primed finish and are sold each. **Hardware is not included.**

PCP Application

- 82045** Right 1979-84 (90756-79A)
- 82046** Left 1979-84 (90757-79A)
- 82047** Right 1985-92 (90756-85)
- 82048** Left 1985-92 (90757-85)
- 82049** Right 1993-on (90756-93)
- 82050** Left 1993-on (90757-93)
- 23054** Lid gasket 1982-92 (90633-82A) (each)
- 23056** Lid gasket 1993-on (90675-93A) (each)



23056

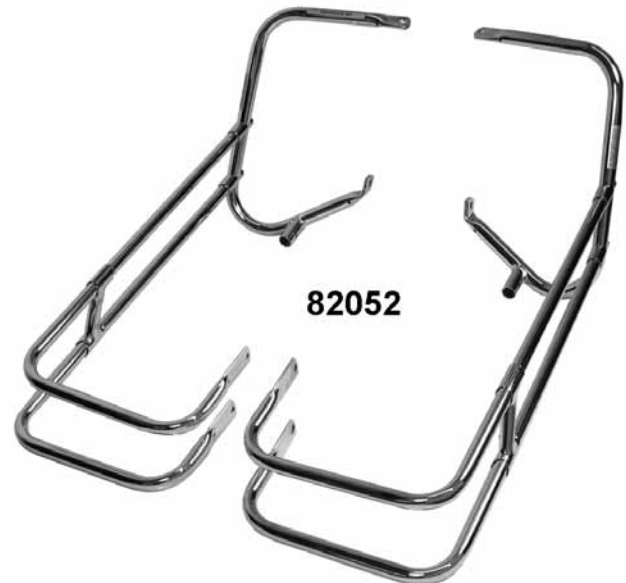

82052

Chrome FLH Saddlebag Guard Kit

Protect FLH fibreglass bags using this left and right chrome rail set.

PCP Application

- 82052** FLHT 1995-96, FLHR 1994-96, FLHS 1993 (90839-93A)
- 82053** FLHT, FLHR, FLHTCUSE/2/3 1997-08, FLTR 1998-03 (91216-97) (not 1998-on FLHRS, FLHRCI or 2006-on FLHX)

Saddlebags

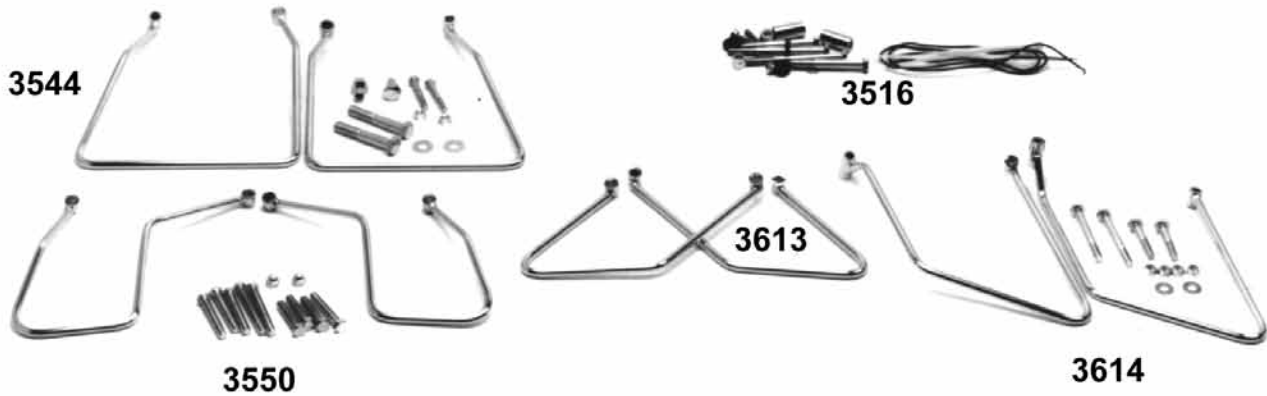

Chrome Saddlebag Supports

Designed to fit the contour of the fender struts and protect your bags from the brake caliper and swingarm.

PCP Application

- 3544*** 1982-93 XLH 5-3/4" (90799-86)
- 27219*** 1994-on XLH (except XL 1200S and 2002-03 XL883R) (need #27220 kit) 5-5/8" (90799-94)
- 3550** 1971-85 FX-FXE 7-3/8" (90584-85)
- 3613** 1984-99 FXST-FLST 6-1/4" (91790-84A)
- 3614*** 1982-86 FXR 7-1/4" (90587-85A)
- 27197** 1991-01 FXD, 1996-05 FXDWG 10-1/4" (90589-91C)
- 27221** 1993-95 FXDWG (90593-93)
- 3516** Relocation kit for FXR 1982-86 (90504-82)
- 27220** Relocation kit (68471-94C)

Note: Relocation kit #3516 is required for #3544 and #3614
Relocation kit #27220 is required for #27219



Chrome Trim Rail Kit

Use this rail kit to accessorize FL saddlebag top covers while providing protection from scratching. FLT, FLHT, FLT, FLHR, FLHS and FLH (except FLHRC/S 1998-on)

45298 53662-87T

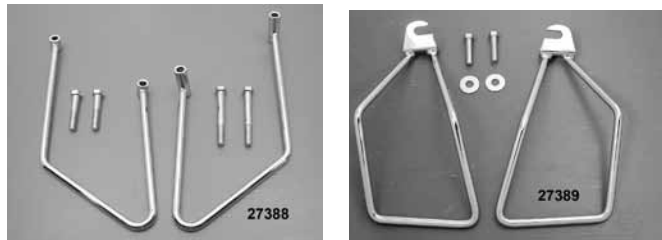

FXST Chrome Saddlebag Supports 2000-on

Are designed to fit the contour of the fender struts and protect your bags from the brake caliper and swing arm.

PCP Type

- 27388** 2 Bolt
- 27389** 1 Bolt

Fiberglass Saddlebag Rivets

PCP Size (1/8" length)

- 10390** 5/16" (90965-63) (50 pack)
- 10391** 1/4" (90966-67) (10 pack)
- 10392** 3/8" (90967-64) (100 pack)



Saddlebag Support Cushion 1993-on

Black rubber cushions replace 90764-93.

23083 Each

Saddlebag Support Cushions 1983-92

Black rubber cushions are sold each to replace 90764-83.

23082



Chrome Saddlebag Top Rails

Rails are stamped "Classic" and include hardware. Fits 1993-on Touring models with hard bags. (Not for use with leather bags or wing tips)

64828 53670-93

Tour Box



Leggins

Splash and weather shields which attach to front engine bar by easy close snaps. Made from heavy naugahyde construction. Not for use with Mustache engine guards.

PCP Application

29406 FLT, FLHT 1980-on (58502-80B)



Front Engine Guard Soft Covers w/Logo (USA)

Soft lowers feature an embossed emblem and fit front engine guards on 1980-83 and 1988-on FLHT, FLHX and FLHR models without fairing lowers. (Not for mustache engine guards)

29435 58525-95A



Chrome Billet Saddlebag Latch

Replaces original type latch on all 1993-on Touring models. Includes mount hardware.

64317 90645-03



T/L King Tour Pak Cover 1990-05

99991 79041-90 (Primer)

King Tour-Pak Top Lid Gasket 1983-05

23057 53415-83A
(each)



Touring Pack Chrome Latch

Fits late rear packs and saddlebags on FLT models.

29114 90681-95A

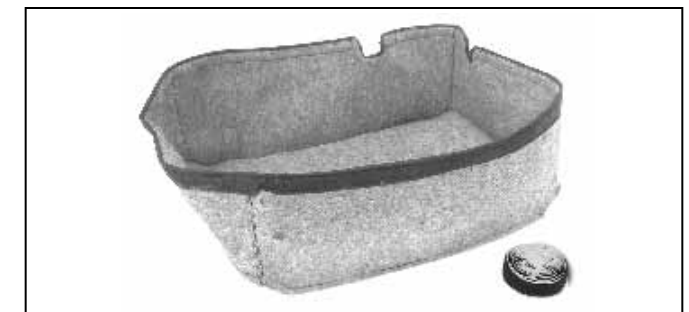

Tour-Pak Liners (standard shown, but n/a)

Liners for chopped tour-paks install in minutes to protect stored goods. Liners are easily removed for cleaning and are sold each.

PCP Application

71026 All models with chopped tour-pak

Saddlebags

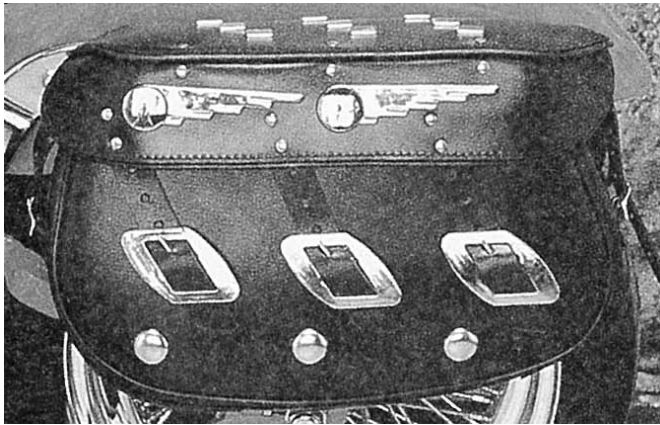

Speed King Saddlebags

1954-57 Speed King style reproduction bags are constructed from heavy leather and measure 20"W x 12 1/2"H x 5"D. Bags include adapter kit to protect from shock and swing arm damage. Fits FXST 1984-99.

75656

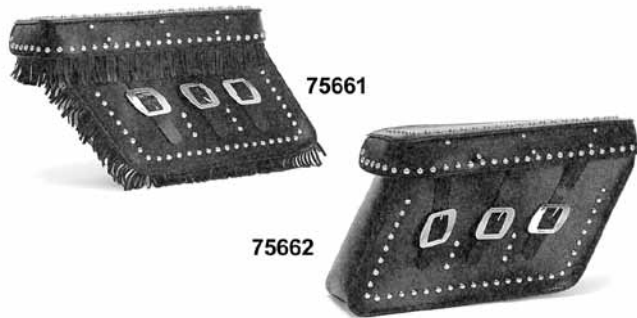

Molded Leather Saddlebags FLT, FLHT, FLHS

Nostalgic leather bags feature an ABS molded back, black piping and can be ordered with or without fringe. Fits all FLT, FLHT, FLHS 1985-92. (19 182"L x 12"H x 7"D)

75661 Fringed

75662 Without fringe



Leather Saddlebags

These genuine leather saddlebags feature a braided trim design, three buckle closure, metal conchos and an adjustable yoke. Measurements: 12" height, 7" depth, 16" length.

75822 Pair



Loctite Saddlebags

Reproduction of original on 1946-48 models including chrome plates to fit all rigid frames. Constructed of heavy black leather with an orange rosette detail. Unique design lid keeps bags closed and in shape. Available to fit FXST, FLST 1984-on with no turn signal relocation necessary. (11785-43)

75530 Rigid

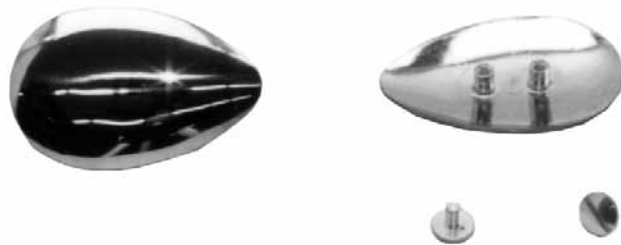

S/S Saddlebag Spoons

Screw-in fasteners easily mount for a variety of uses. Pairs.

75652



SUPER COVER

Dow 'Super Cover' Motorcycle Cover

Heavy weight polyester covers feature waterproof undercoating, scratch resistant, aluminized panel reinforced grommets for use with a cable or bar lock and an elastic corded hem that ensures a secure fit. PCP# 91701 and 91702 also include a flannel liner for added windshield protection.

PCP Description

91701 Fits fully accessorized Dresser FLHT (98715-85V)

91702 Fits all Twins w/sissy bar (no Dresser) (98705-85V)

91703 Fits all models without sissy bar

91704 XX-Large size

Bags & Pouches

Travelcade luggage is made of Leather Tek, a synthetic leather that is actually better than leather for motorcycles. Leather Tek is a heavy weight leathery material that is extremely durable and carefree. This remarkable material does not stain, mildew or rot and is completely waterproof. No more stiffening or cracking. Leather Tek is cleaned easily. A quick wipe with a cloth keeps these bags looking sharp! Leather Tek, cows wish they could do better.



Double Strap Tool Roll

With dual strap. Heavy leather roll, measures 11"x3"x6" tall.
59484



Leather Tool Pouch

8 oz leather, 4"x4"x11" wide. Secures with 2 straps
59482



Leather Tool Pouch

Pouch measures 11" wide and has a 5" diameter.
75821



Decorative Saddlebag and Fender Trims

These precision-stamped stainless steel trim pieces are reproductions of the 1940s and '50s style saddlebag trims. Available in a pointed tab-mount style for easy installation on all leather goods or in a threaded stud-mount style to be mounted on the sides of fenders, fiberglass saddlebags or trunks. A 'touch of nostalgia' for any motorcycle. Fit Big Twin and Sportster® models. **Sold in pairs.**

16600 Pointed tab-mount
16601 Stud mount



Seat Rail Pouch (Travelcade)

Features: Eagle mounted concho enhances clean style, convenient storage. Size: 8" x 10" x 3-1/2".
75620 Classic Pouch



Seat Rail Pouch (Travelcade)

Features: Classic buckles and fringe, compliments many other bags and a great companion with our classic angle bag. Size: 8" x 10" x 3-1/2".
75630 Classic Special

Large Leather Sissy Bar Bag

Custom mount to your sissy bar. 15"H x 11"W x 4"D.
91700



Lubricants

Russell Silicone Brake Fluid

Long life DOT 5 silicone brake fluid was specifically developed for severe service and competition applications. It will not boil at temperatures up to 500 degrees farenheit. It will not absorb moisture and is recommended for use with Russell Powerflex hoses. Sold in 12 oz. bottles.

6754 Each bottle



METAL MAJIC

Recommended for sealing all metal and painted surfaces, including aluminum, chrome, stainless steel, fiberglass and painted surfaces. Made with DuPont Teflon for use with all quality metal polish.

91002 Sold each



91010



91012

Spectro Heavy Duty Fork Oil

Type 'E' and 'Heavy' for superior damping and long lasting lubrication with anti-foaming, anti-rust and anti-corrosion additives. It offers extreme temperature stability, minimizes fluid leakage and resists fading over a wide range of temperatures.

Sold each

91010 Fork Oil, Type 'E', synthetic-20 weight

91012 Fork Oil, Heavy, synthetic- 40 weight



Paint

12 ounce cans sold each.

6759 Gloss black frame paint

Spectro Golden American Synthetic Blend Engine Oil (sold each)

Incorporates the highest shear stable viscosity index for gear driven cams and hydraulic lifters Good for 5000 miles engine service without compromising wear and oxidation protection

91013



Gasgacinch Gasket Sealer

Sold as 4 oz. can.

59476



Gasoila Sealant

Available in hard setting red varnish or soft set blue/white with teflon. Red sealant is the original sealer for sealing holes on porous surfaces and for use on the inside of crank cases and cam covers. Blue-white seals threaded joints on pipe threads and fittings. Both types are insoluble in oil, gas and solvents. Sold in 1/4 pint can that includes brush.

59474 Red varnish

59475 Blue/white